

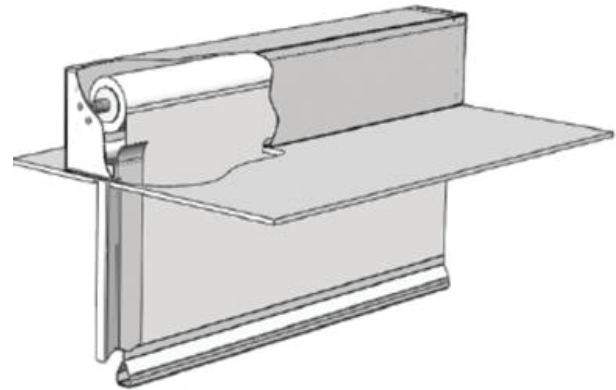

GENERAL DESCRIPTION:

The SD240GS is a UL Listed, Labeled, and Recognized GRAVITY FAIL SAFE (GFS) deployable fire protective smoke curtain system composed of a glass-fiber fabric in a Leinwand weave rolled on a round steel tube in a fire rated assembly. The curtain remains retracted above the finished ceiling by a low voltage system until activated by fire alarm or smoke alarm at which point it descends at 6 in/sec. and creates a smoke and fire barrier. The curtain can also be non-motorized when activated by a fusible link. The SD240GS system consists of:

- A single or multi roller assembly with a 0.05 in. thick galvanized steel head box with a minimum 7.125 in. x 7.125 in. with a maximum span up to 60 ft. and drop height of 45 ft.
- A 24 V motor control circuit (MCC) housed the steel enclosure and mounted onto the motor end of the head box. NFPA 70 compliant tubular DC low voltage motor interfaced with Group Control Panel (GCP) and a suitably weighted bottom bar with a 1-hr UL 263 Listed steel bottom bar.
- The fabric curtain manufactured from 660g/m² stainless steel, wire reinforced, woven glass fiber fabric coated on each side with silver polyurethane. The fabric is UL 263 Listed, UL10D Listed, UL10B Tested for up to 3 hrs to 1800°F.
- Removable fire rated cover plates incorporated to allow access to curtain rollers.
- Curtain passes through fire rated galvanized steel auxiliary rails (side guides) that can be powder coated or prime coated in finish.
- Optional hand liftable grab strap for manual egress per section 3.1.1. of ICC AC77.
- Optional split curtain as secondary mean of manual egress per section 3.1.2. of ICC AC77.
- Egress switches on both sides of curtain per ANSI section 3.2.5 of AC 77. File R26410 is Ble.



STANDARDS:

The SD240GS is certified for quality by ISO 9000, meets and exceeds the requirements of:

- IBC 715.4 C Smoke Door Assembly
- NFPA 105 Compliance
- NFPA 101 Compliance
- UL 10D Listed, Labeled, Classified and Recognized for Fire Protective Curtains
- UL1784 Listed, Labeled, Classified, and Recognized
- UL 263 (ANSI, ASTM E119) Time-Temperature Curves
- UL 864 Listed, Labeled and Recognized
- UL 555 Listed, Labeled and Recognized
- UL 10B Time Temperature Curves
- UL 10C Time Temperature Curves

PERFORMANCE:

- 3 hours fire rated at 1800°F
- 2000 cycles at normal ambient temperatures in the range (32°F - 140°F) and can withstand hot air and smoke at temperatures at UL 10B and ANSI/ASTME119 Time Temperature curves.
- 3-hour smoke and fire curtain (UL 10D/ANSI/ASTM E119)
- Bottom bar deploys ~8"/second. Heavier bottom bar deploys ~12"/second.



FABRIC:

The C41000WK fabric is fabricated from stainless steel, wire reinforced, woven glass fiber fabric coated on each side with silver polyurethane. The fabric is manufactured & tested to withstand 1800°F for a period of 3 hrs. The curtain fabric is manufactured from a unique “Leinwand” weave which offers an even surface and allows a tighter interlacing of the fabric edges. The tensile strength of Leinwand weave fabric is 10% greater than other fabrics due to constant thread tension.



FABRIC		
Style: C41000WK		Rating for 1832°F for 180 minutes
Test Characteristics	Unit	Data
Weight of fab	g/m ²	550 ± 5%
Width	in.	39.4 ± 1%
Thickness	in.	0.017 ± 5%
Weave		Leinwand
Threads /warp	Per cm.	16.0 ± 3%
Fineness /warp	Tex	EC9 - 68x2 ± 5%
Tensile strength /weft	Lbf/ft	6167.0 ± 5%
Threads /warp	Per cm.	10.0 ± 3%
Fineness /weft	Tex	EC9 - 68x2 ± 5%
Tensile strength /weft	Lbf/ft	3426.1 ± 5%
Coating Quantity	G/m ²	35 ± 5%
One side/ Both sides	1/2	2
Application temp.	°F	932 (Glass)

HEADBOX INSTALLATION OPTIONS

There are many installation options that suit all types of ceiling configurations and provide a broad array of flexibility.

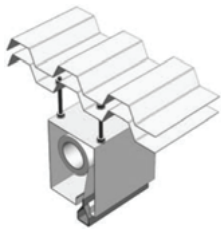

Unistrut Installation

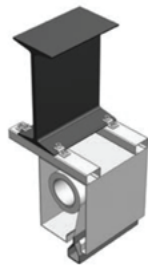

I Beam

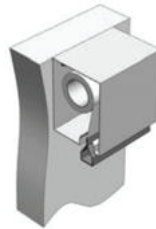

Back Mounted

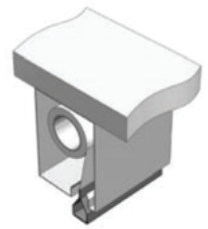

Top Mounted

FINISHED CEILING OPTIONS

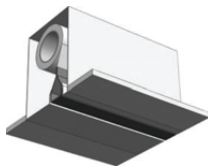

Flush

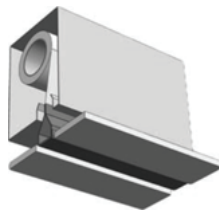

Shadow Gap

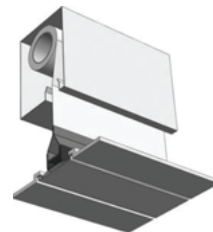

Downstand Neck

SIDE GUIDE CONFIGURATION

The side guide can either be exposed or recessed flush as shown below:

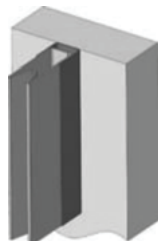

Exposed

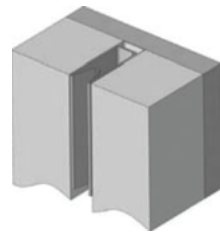

Flush

GROUP CONTROL PANEL (GCP):

The curtain deployment mechanism is directly synced and integrated in the fire alarm emergency systems.

When an alarm signal is detected, the GCP will automatically trigger all the curtain systems to deploy in a controlled descent under gravity. Each GCP controls a maximum of 5 Motor Control Circuit (MCC). In normal operating conditions the GCP provide a 24v AC supply the MCC to keep the curtains in retracted condition. Should smoke be detected, the fire alarm control system will signal the GCP. The latter will open the circuit loop, remove the voltage and the curtains will deploy under gravity at a controlled speed.

MOTOR CONTROL CIRCUIT SPECIFICATION (MCC):

- Nominal Voltage= 24 V
- Nominal speed = 3100 rpm
- Dimensions: 145 mm x 250 mm x 50 mm
- Continuous Torque : 1400 Ncm
- Efficiency : 0.70
- Ratio : 100.00
- Shaft Load Capacity – Axial : 150 N
- Shaft Load Capacity – Radial : 250 N
- A dynamic braking system housed in the motor control circuit

FIRE-PROTECTIVE SMOKE CURTAIN DIAGRAM

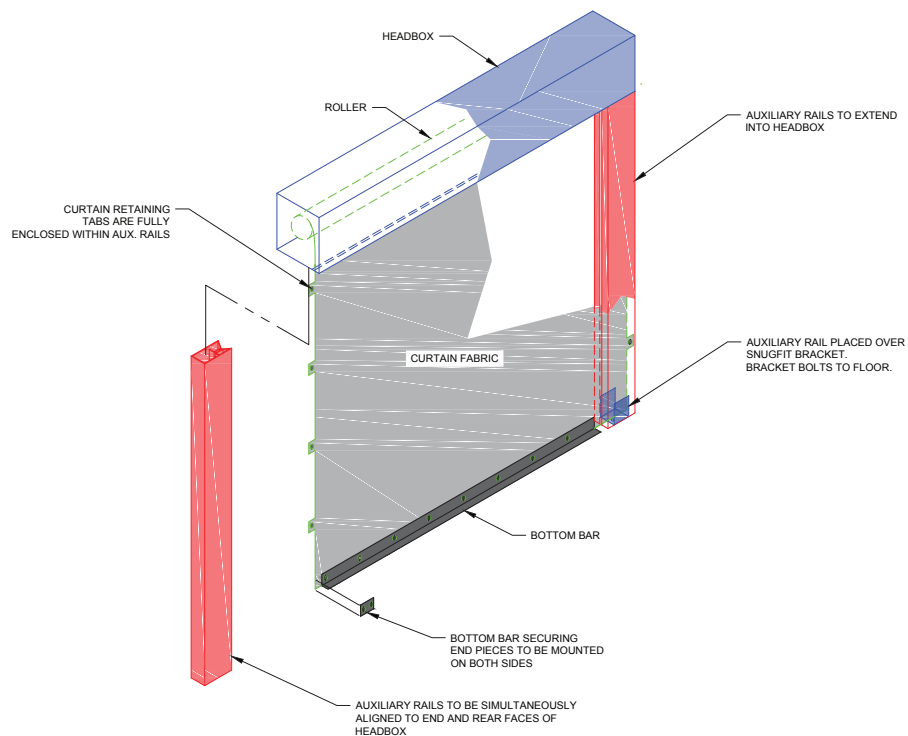

12310 Pinecrest Road, Suite 300, Reston, VA 20191 • Phone: 888.917.8777 • Fax: 888.917.8777
Washington, DC • Boston • New York • Miami • Dallas • San Francisco
www.us smokeandfire.com • aeteam@us smokeandfire.com



UL LOGO IS A REGISTERED TRADEMARK OF UNDERWRITERS LABORATORIES