

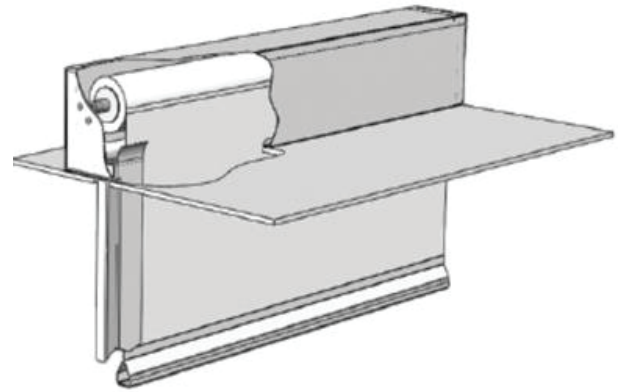

GENERAL DESCRIPTION:

The SD240GS® is a GRAVITY FAIL SAFE (GFS) deployable fire protective smoke curtain system composed of a glass-fiber fabric in a Leinwand weave rolled on a round steel tube in a fire rated assembly. The curtain remains retracted above the finished ceiling by a low voltage system until activated by a fire alarm, smoke alarm or fusible link at which point it descends at 6 in./sec. and creates a smoke and fire barrier. The SD240GS® system consists of:

- A single or multi roller assembly with a 0.05 in. thick galvanized steel head box with a minimum 7 in. x 7 in. with a maximum span up to 146 ft. and drop height of 45 ft.
- A 24 V motor controller circuit (MC) housed the steel enclosure and mounted onto the motor end of the headbox. NFPA 70 compliant tubular DC low voltage motor interfaced with Control Panel (CP) and a suitably weighted bottom bar with a steel bottom bar.
- The fabric curtain manufactured from 660g/m² stainless steel, wire reinforced, woven glass fiber fabric coated on each side with silver polyurethane. The entire assembly including head box is UL10D Listed for up to 2 hour wall.
- Removable fire rated cover plates incorporated to allow access to curtain rollers.
- Curtain passes through fire rated galvanized steel auxiliary rails (side guides) that can be powder coated or prime coated in finish.
- Optional split curtain as secondary mean of manual egress.
- Egress switches on both sides of curtain per ANSI section 3.2.5 of AC 77.
- Standard powder coat colors: Gray, black and white.



STANDARDS:

The SD240GS® is certified for quality by ISO 9000, meets and exceeds the requirements of:

- IBC 715.4 C Smoke Door Assembly
- NFPA 105 Compliance
- Tested to UL 10D
- Tested to UL1784
- Tested to UL 10B - 20 minutes (no hose)
- Tested to UL 10C - 20 minutes (no hose)
- Tested to UL 864

PERFORMANCE:

- 2000 cycles at normal ambient temperatures in the range (32°F - 140°F)
- Bottom bar deploys ~6"/second. Heavier bottom bar deploys ~12"/second.
- Standard BMS Relay
- Optional leading edge safety sensor
- Optional obstruction beam sensor
- Optional bottom bar descent OK sensor



FABRIC:

The fabric is fabricated from stainless steel, wire reinforced, woven glass fiber fabric coated on each side with silver polyurethane. The fabric is manufactured & tested to withstand 1800°F. The curtain fabric is manufactured from a unique weave which offers an even surface and allows a tighter interlacing of the fabric edges. The tensile strength of weave fabric is 10% greater than other fabrics due to constant thread tension.



FABRIC		
Test Characteristics	Unit	Data
Weight of fab	g/m2	550 ± 5%
Width	in.	39.4 ± 1%
Thickness	in.	0.017 ± 5%
Threads /warp	Per cm.	16.0 ± 3%
Fineness /warp	Tex	EC9 - 68x2 ± 5%
Tensile strength /weft	Lbf/ft	6167.0 ± 5%
Threads /warp	Per cm.	10.0 ± 3%
Fineness /weft	Tex	EC9 - 68x2 ± 5%
Tensile strength /weft	Lbf/ft	3426.1 ± 5%
Coating Quantity	G/m ²	35 ± 5%
One side/ Both sides	1/2	2
Application temp.	°F	932 (Glass)

HEADBOX INSTALLATION OPTIONS

There are many installation options that suit all types of ceiling configurations and provide a broad array of flexibility.

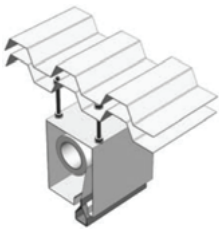

Unistrut Installation

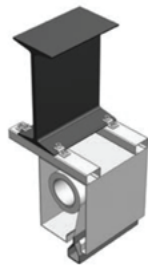

I Beam

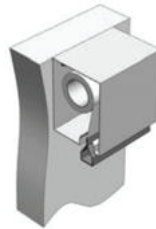

Back Mounted

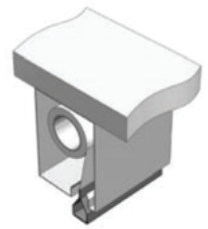

Top Mounted

FINISHED CEILING OPTIONS

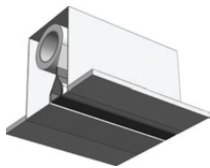

Flush

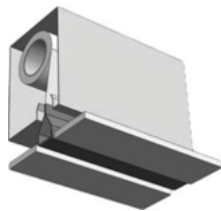

Shadow Gap

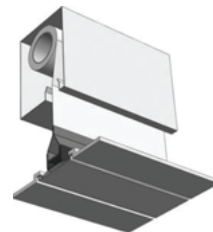

Downstand Neck

SIDE GUIDE CONFIGURATION

The side guide can either be exposed or recessed flush as shown below:

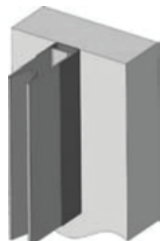

Exposed

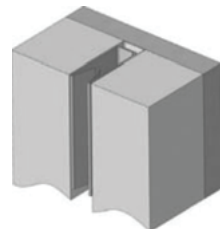

Flush or 2" max recessed

CONTROL PANEL (CP):

The curtain deployment mechanism is directly synced and integrated in the fire alarm emergency systems.

When an alarm signal is detected, the CP will automatically trigger all the curtain systems to deploy in a controlled descent under gravity. Each CP controls a maximum of 4 Motor Controller (MC). In normal operating conditions the CP provide a 24v AC supply the MC to keep the curtains in retracted condition. Should smoke be detected, the fire alarm control system will signal the CP. The latter will open the circuit, remove the voltage and the curtain will deploy under gravity at a controlled speed.

MOTOR CONTROL CIRCUIT SPECIFICATION (MCC):

- Nominal Voltage= 24 V
- Nominal speed = 3100 rpm
- Dimensions: 145 mm x 250 mm x 50 mm
- Continuous Torque : 1400 Ncm
- Efficiency : 0.70
- Ratio : 100.00
- Shaft Load Capacity – Axial : 150 N
- Shaft Load Capacity – Radial : 250 N
- A dynamic braking system housed in the motor controller

FIRE-PROTECTIVE SMOKE CURTAIN DIAGRAM

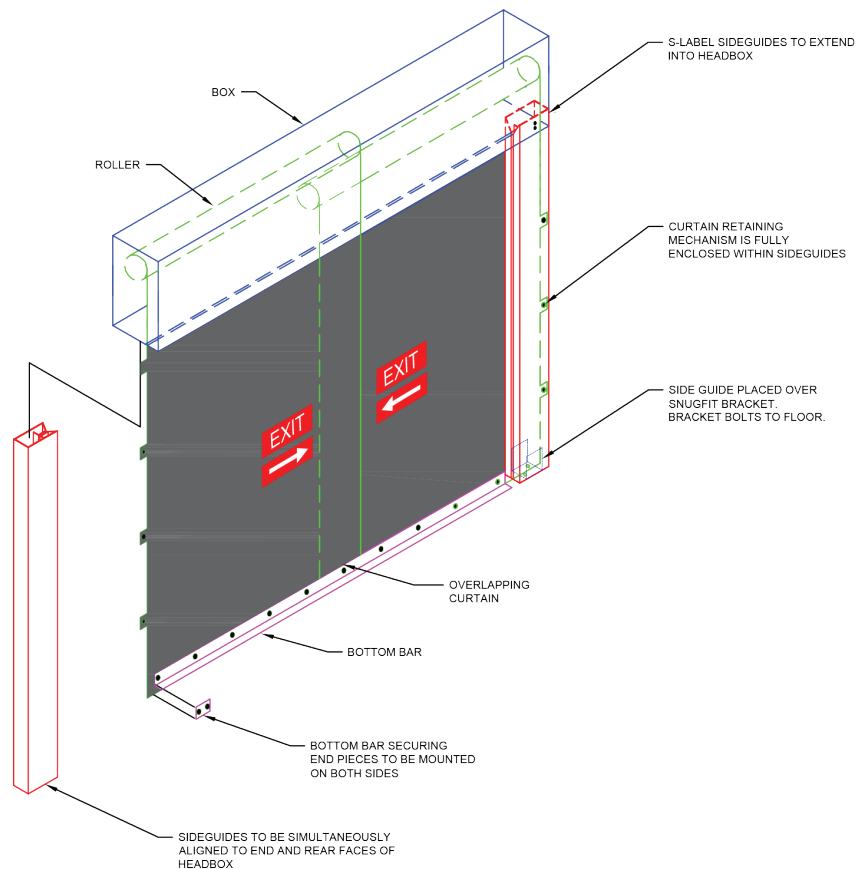

U.S. SMOKE & FIRE®

12310 Pinecrest Road, Suite 300, Reston, VA 20191 • Phone: 888.917.8777 • Fax: 888.917.8777
Washington, DC • Boston • New York • Miami • Dallas • San Francisco
www.us smokeandfire.com • aeteam@us smokeandfire.com

